

EBARA

GP2006EA

VERTICAL MIXED-FLOW PUMPS

VX Series Model VY.VZ

Bore: 350mm(14in)~





FEATURES

- Large variety of options to meet all customer requirements.
- Over 100-meter-head per single stage.
- Welded guide casing is also available.
- Dry bearings not requiring external flushing are also available.
- Guaranteed high performance, quality and prompt delivery.
- And the following advantages, typical of vertical mixed-flow pumps:
 - Smaller installation space than that of horizontal pumps.
 - Submerged impeller dispenses with the need for priming and allows pumping up of water from deep sources.

GENERAL SPECIFICATIONS

Service	Water intake/transfer for general industrial use; fire-fighting; sea water desalination; water intake/transfer for city water and sewerage works; CWP for power plant; irrigation and drainage; river water drainage; etc.
Liquid	Fresh water; river water; sea water; brine; etc. Temperature: 0~60°C (32~140°F)
Application range	Capacity: 13 m ³ /min ~ (3400USGPM) Total head: 8 m (26 ft) ~ Disch. bore: 350 mm (14 in)~

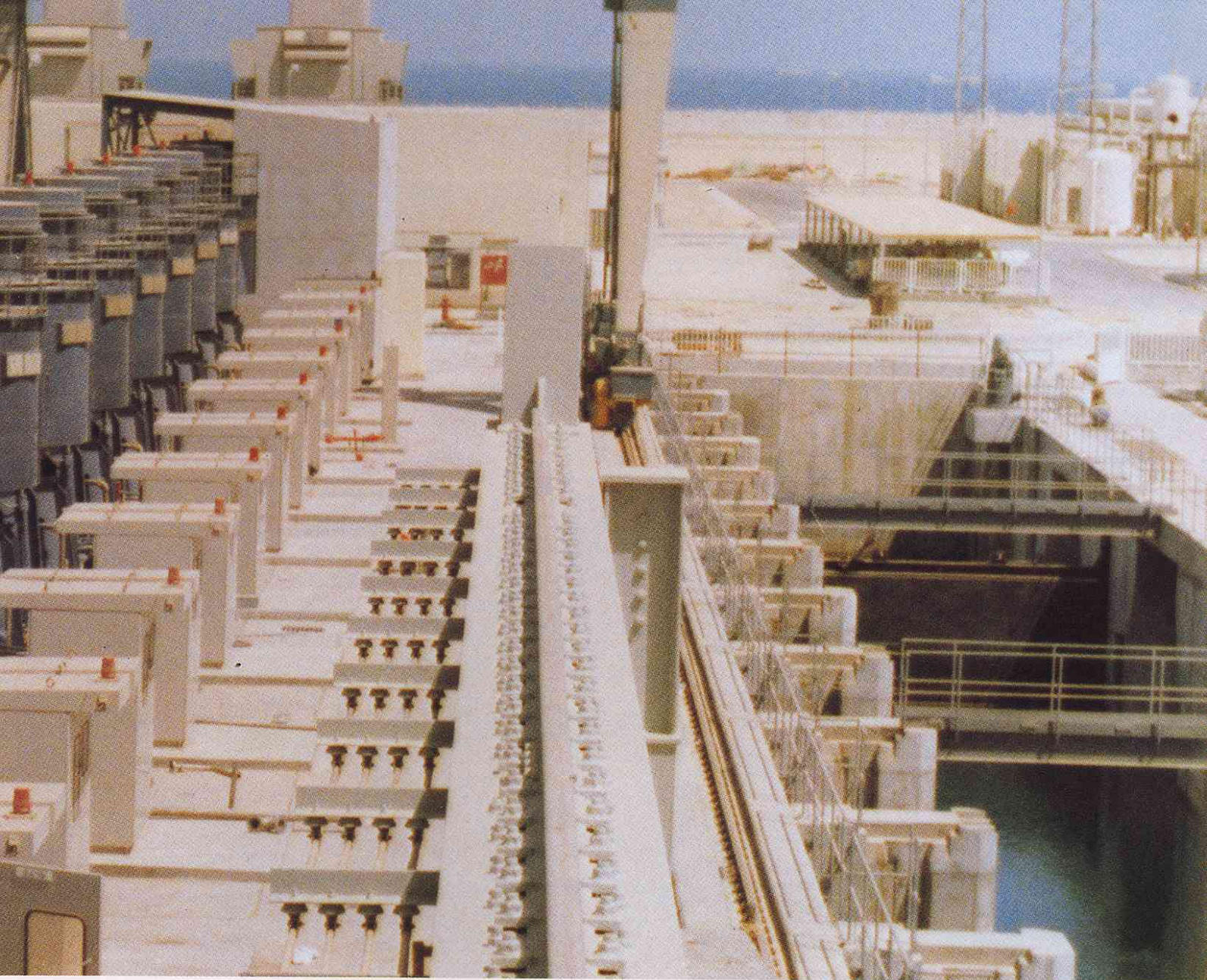

CONSTRUCTION

	Standard	Option
Pump (installation) type	One-floor surface-discharge type	Two-floor type; underground-discharge type; pull-out type (Model VYN-VZN); pit-barrel type (Model VYB)
Direction of rotation	CW (viewed from driver)	—
Disch. Flange	JIS IOK F.F.	Any standard
Thrust bearing	Oil-bath anti-friction bearing	—
	Located in motor for large horse power	Located in pump
Submerged bearing	Rubber bearing	Dry bearing not requiring external flushing at startup or shutdown.
Shaft seal	Gland packing	Mechanical seal
Accessories	Pump base; coupling; drain piping; anchor bolts	Rubber bearing lubrication system; suction strainer; auto air vent valve; compound gauge; tools; touch-up paint; etc.

MATERIALS (Typical material combinations)

	Fresh water	River water	Sewage	Sea water
Casing	Cast Iron / Rolled Steel	Cast Iron / Rolled Steel	Cast Iron / Rolled Steel	Low Alloy C.I. / Ni-resist D2 / 316 S.S.
Impeller	Bronze	Bronze / 304 S.S.	Bronze / 304 S.S.	316 S.S.
Shaft	Carbon Steel	Carbon Steel	420 S.S.	316 S.S.
Shaft sleeve	304 S.S.	304 S.S.	304 S.S.	316 S.S.
Shaft-enclosing tube	Carbon Steel	Carbon Steel	304 S.S.	316L S.S.
Pump base	Cast Iron			
Driver pedestal	Rolled Steel			

- Other materials such as Nickel aluminium bronze, Duplex stainless steel, Monel, Alloy 20, etc. can also be applied.
- Selection of material requires careful study of the properties of the liquid handled and of the operating conditions, etc. For specific details, please consult our factory.

Many Options for Optimal Designs

Basic Types

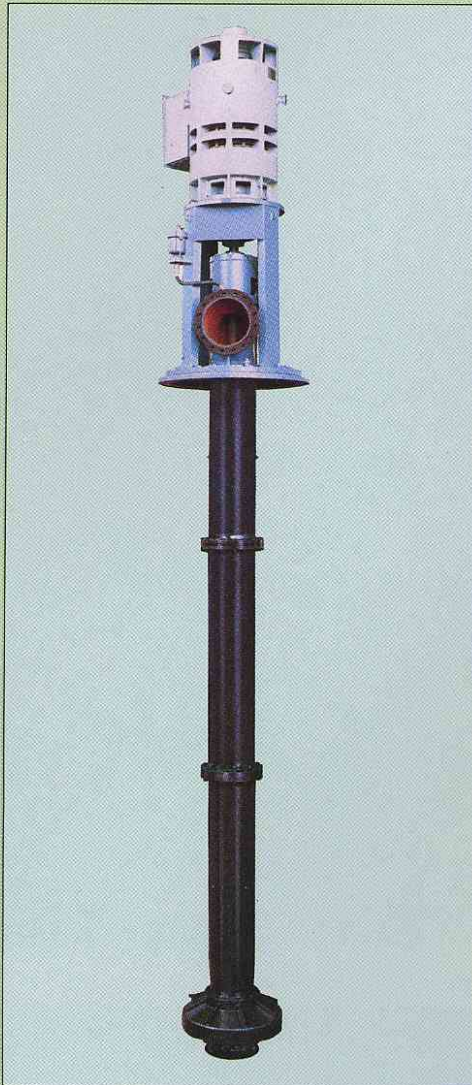

High-head pump, with thrust bearing in pump

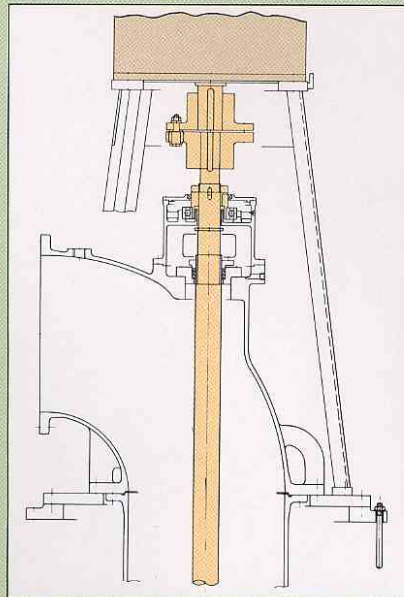

Thrust bearing in pump, Open line shaft

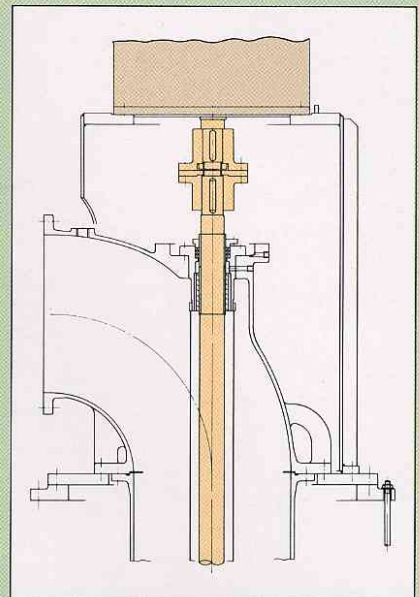

Thrust bearing in driver, Enclosed line shaft

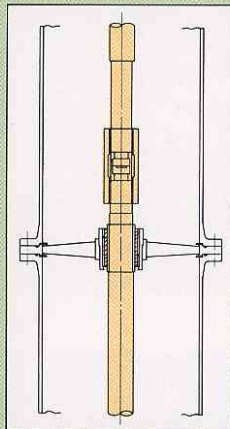

Medium-power coupling, Open line shaft

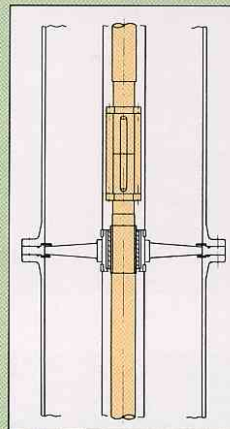

Large-power coupling, Enclosed line shaft

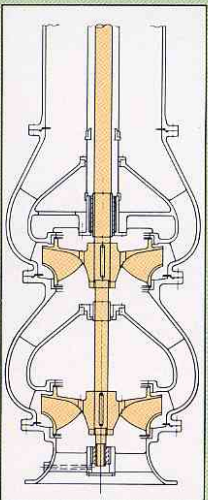

Two-stage construction

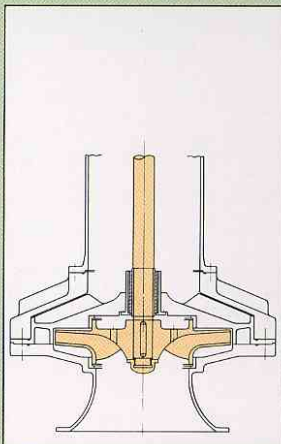

High-head closed impeller

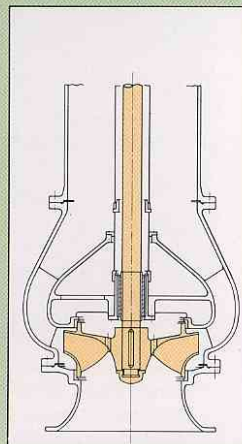

Medium-head closed impeller

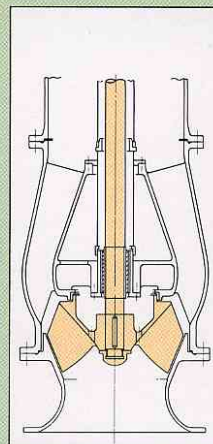

Low-head semi-open impeller

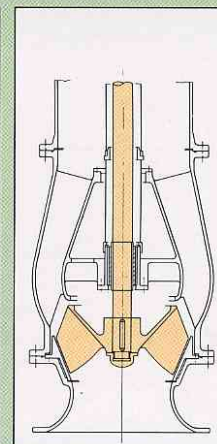

With casing liner

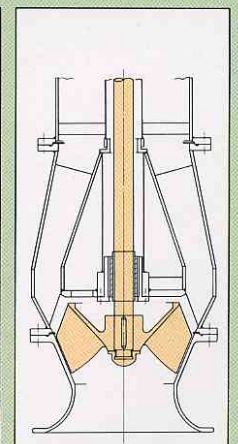

Welded guide casing

Types of Installations & Drive Methods

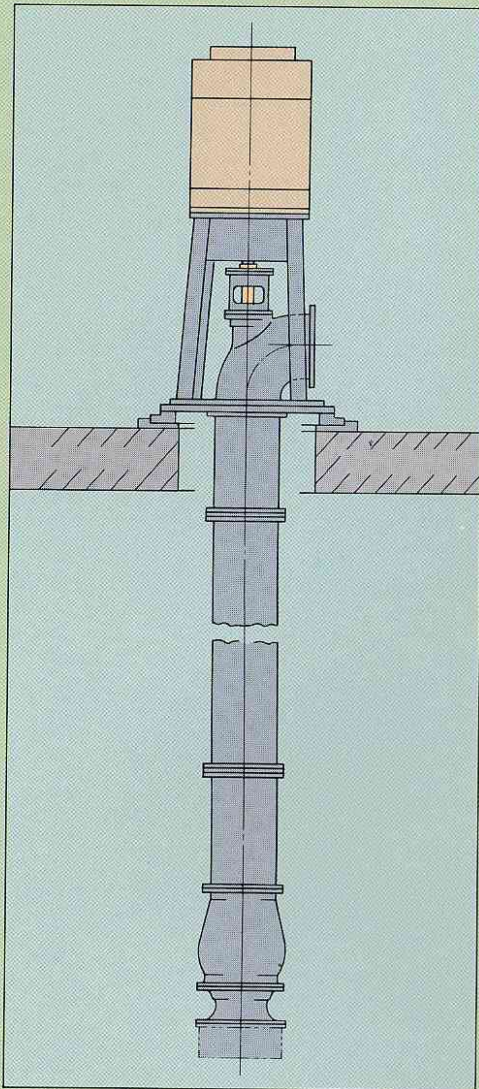

Basic type

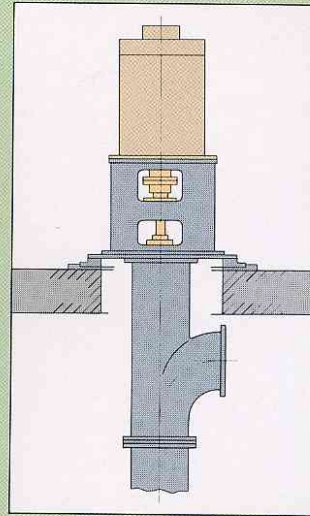

Underground discharge

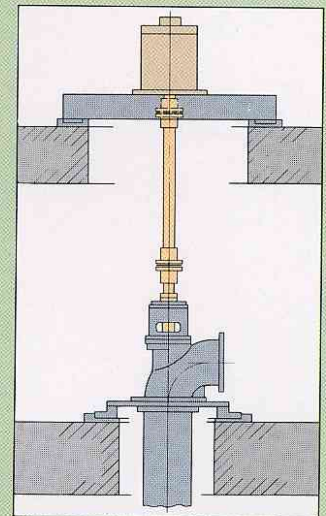

Two-floor installation

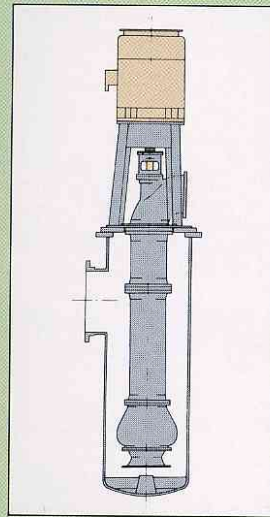

Pit-barrel type
Model "VYB"

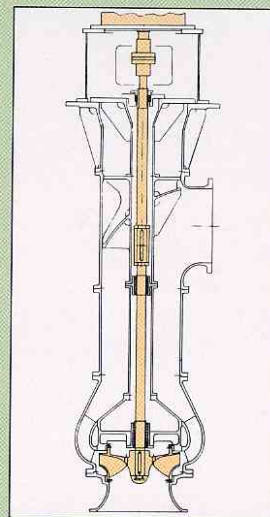

Pull-out type (Medium head)
Model "VYN · VZN"

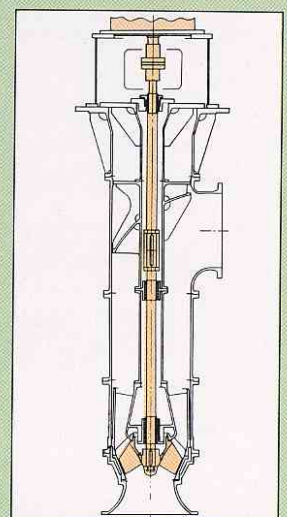

Pull-out type (Low head)
Model "VZN"

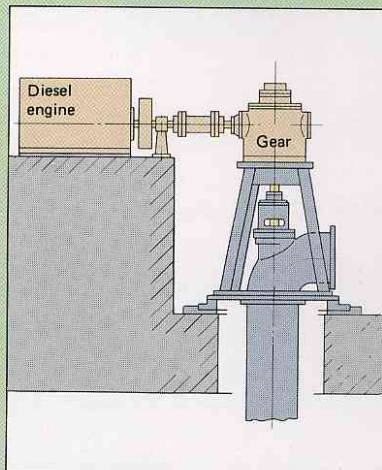

Diesel engine drive

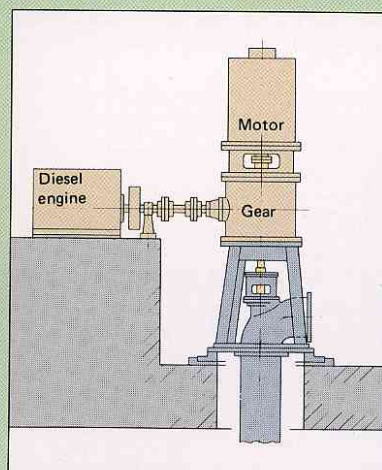

Motor & diesel engine drive

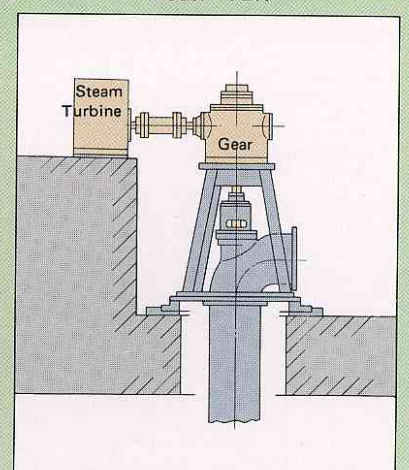

Steam turbine drive

SELECTION CHART

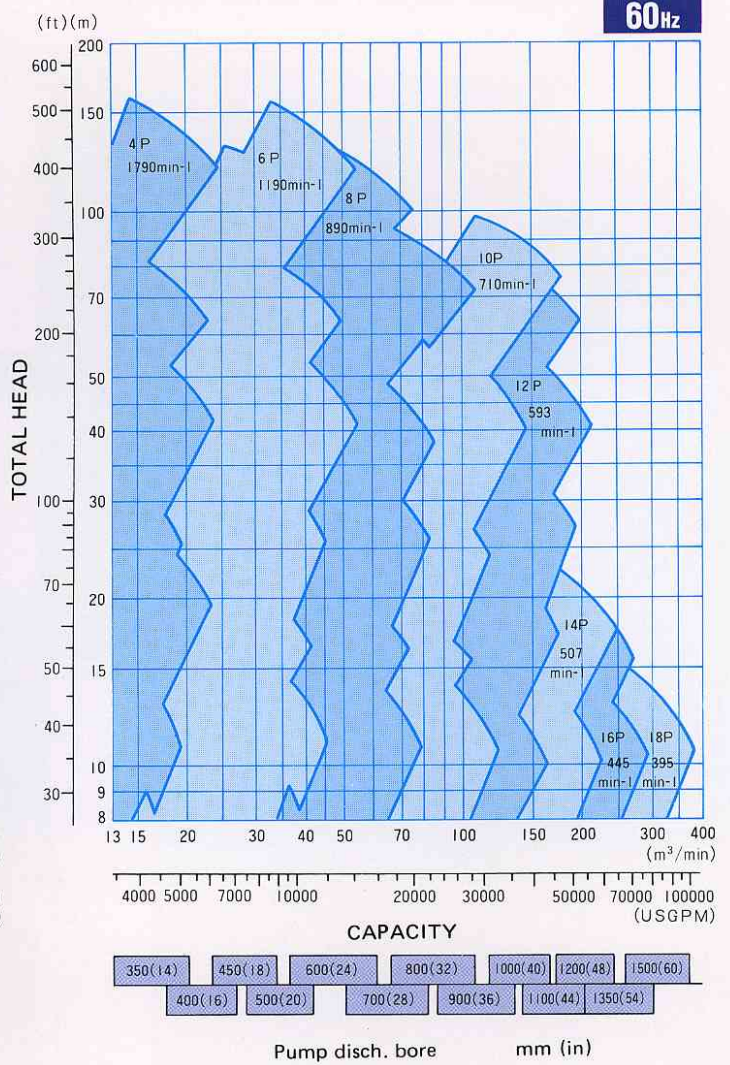
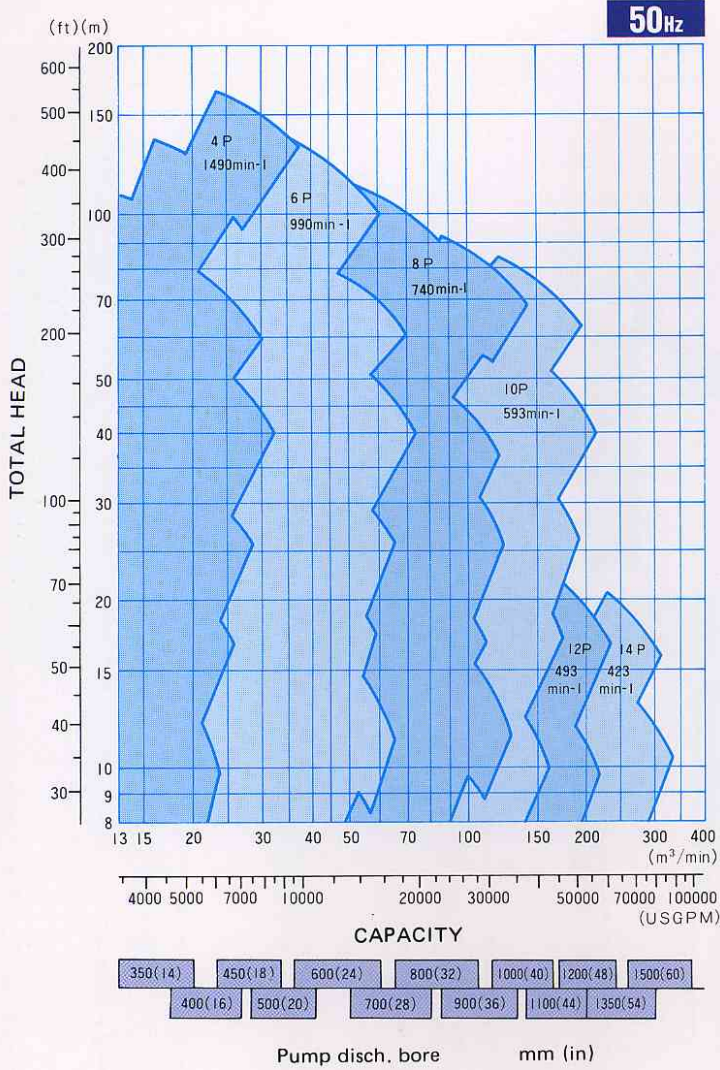

PUMP SUMP DIMENSIONS

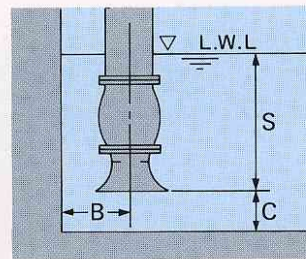
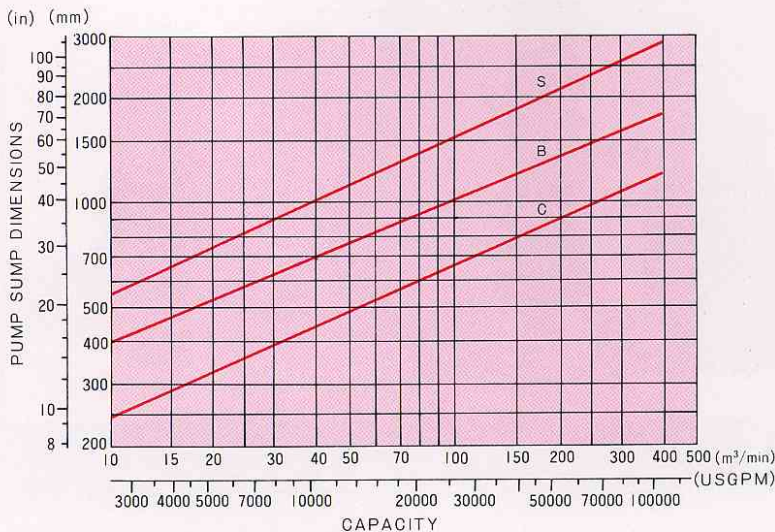

- Pump ratings not in the chart are also applicable.
- Selected bore/speed and sump dimensions may differ depending on actual service conditions. For specific details, please consult our factory.

PUMP MODEL NAME

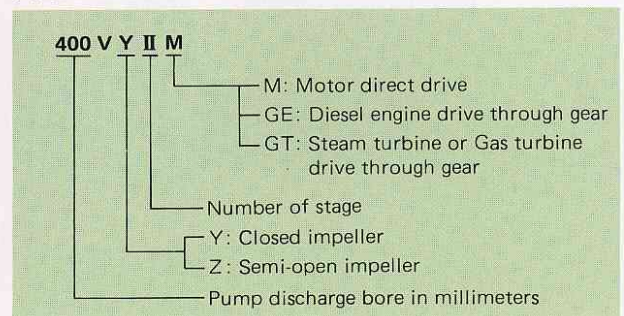

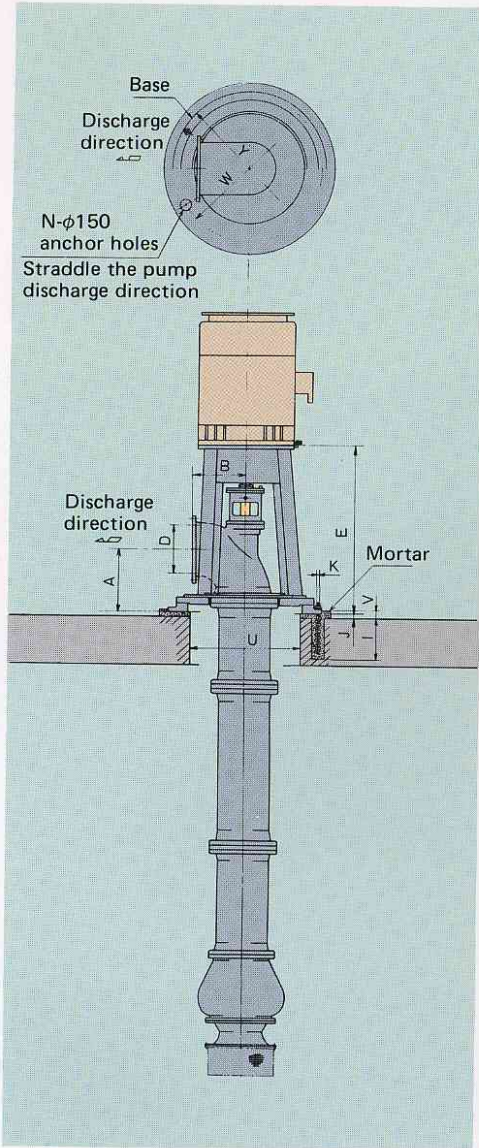

OUTLINE DIMENSIONS

Unit: mm

Discharge Bore D (in)	A	B	E	I	J	K	V	U	W	Y	N
350 (14)	445	400	1500	430	25	22	55	750	1100	1150	4
400 (16)	495	450	1600	500	30	24	60	850	1200	1260	4
450 (18)	550	500	1800	500	30	24	60	950	1300	1360	6
500 (20)	600	550	1900	500	30	24	60	1050	1400	1460	6
600 (24)	725	650	2300	630	40	30	90	1150	1500	1570	6
700 (28)	830	750	2400	630	40	30	90	1350	1700	1770	8
800 (32)	930	850	2500	630	40	30	90	1500	1850	1920	8
900 (36)	1040	950	2700	630	40	30	90	1700	2050	2120	8
1000 (40)	1150	1050	2800	800	50	36	100	1850	2200	2280	8
1100 (44)	1255	1150	3000	800	50	36	100	1950	2300	2380	8
1200 (48)	1355	1250	3100	800	50	36	100	2050	2400	2480	8
1350 (54)	1510	1400	3300	800	50	36	100	2150	2500	2580	12
1500 (60)	1660	1550	3500	800	50	36	100	2350	2700	2780	12

(NOTES)

- Dimensions may differ depending on service conditions.
- For over 70m (230ft) rated head, please consult our factory.



EBARA CORPORATION

Head Office:

11-1, Haneda Asahi-cho, Ohta-ku,
Tokyo, 144-8510 Japan
Phone: 81-3-3743-6111
Fax: 81-3-3745-3356
Internet homepage : <http://www.ebara.co.jp>

Sales headquarter:

NISSAY AROMA SQUARE, 5-37-1, Kamata,
Ohta-ku, Tokyo, 144-8721 Japan
Phone: 81-3-5714-6111
Fax: 81-3-5714-6081

Please send your enquiries to the above International Division

○: Liaison Offices

■ AMERICA

UNITED STATES OF AMERICA

Ebara International Corporation (Sparks, NV)
Aircac, Inc. (Rochester, IN)
Elliott Turbomachinery Co., Inc. (Jeannette, PA)

BRAZIL

Ebara Indústrias Mecánicas e Comércio Ltda.
(Bauru, S.P.)

■ EUROPE

ENGLAND

Elliott Turbomachinery Limited (Basingstoke)

ITALY

- Italy Office (Vicenza)
- Ebara Pumps Europe S.p.A. (Trento)
- Sumoto S.r.l. (Vicenza)

SPAIN

Ebara Espana Bombas S.A. (Madrid)

■ ASIA

PEOPLE'S REPUBLIC OF CHINA

- Beijing Office (Beijing)
- Yantai Ebara Air Conditioning Equipment Co., Ltd.
(Yantai)
- Beijing Ebara Machinery Co., Ltd. (Beijing)
- Ebara Machinery (Shanghai) Co., Ltd. (Shanghai)
- Shanghai Ebara Engineering and Services Co., Ltd.
(Shanghai)
- Ebara Qingdao Co., Ltd. (Qingdao)
- Ebara Densan (Kunshan) Mfg. Co., Ltd. (Kunshan)

TAIWAN

- Taipei Office (Taipei)
- Ebara-Densan Taiwan Manufacturing Co., Ltd.
(Chung Li)
- Ebara-Elliott Service (Taiwan) Co., Ltd. (Taichung)
- Ebara Kailay Environmental Engineering Co., Ltd.
(Taipei)

KOREA

Hyosung-Ebara Co., Ltd. (Seoul)
Hyosung-Ebara Environment Engineering Co., Ltd.
(Seoul)

SINGAPORE

- Singapore Office (Singapore)
- Ebara Engineering Singapore Pte. Ltd.
(Singapore)

MALAYSIA

Ebara Pumps Malaysia Sdn. Bhd (Selangor)
Ebara Environmental Engineering (Malaysia) Sdn. Bhd.
(Selangor)

INDONESIA

- Jakarta Office (Jakarta)
- P.T. Ebara Indonesia (Jawa Barat)

PHILIPPINES

- Manila Branch Office (Manila)
- Ebara Benguet, Inc. (Laguna)

VIETNAM

Ebara Hai Duong Company Ltd. (Hai Duong)
Ebara Vietnam Corporation (Hanoi)

THAILAND

- Bangkok Office (Bangkok)
- Ebara (Thailand) Limited (Bangkok)

INDIA

Kirloskar Ebara Pumps Limited (Pune)

■ MIDDLE-EAST

United Arab Emirates

- Middle East Office (Dubai)

■ OCEANIA

AUSTRALIA

Ebara Pumps Australia Pty. Ltd. (Bayswater, Vic)